

WEPD 6F

TECHNICAL DATA

- **Max flow rate LP>C:** 30 l/min
- **Max setting pressure:** 350 Bar
- **Max working pressure:** 250 Bar
- **Materials:** Aluminium Body, Cartridge in Steel zinc plated
- **Weight:** 2,700 kg

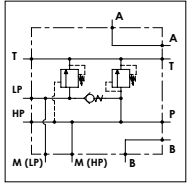

PORTS

HP	1/4
LP	3/8
T	1/2
A	3/8
B	3/8
M(HP)	1/4
M(LP)	1/4

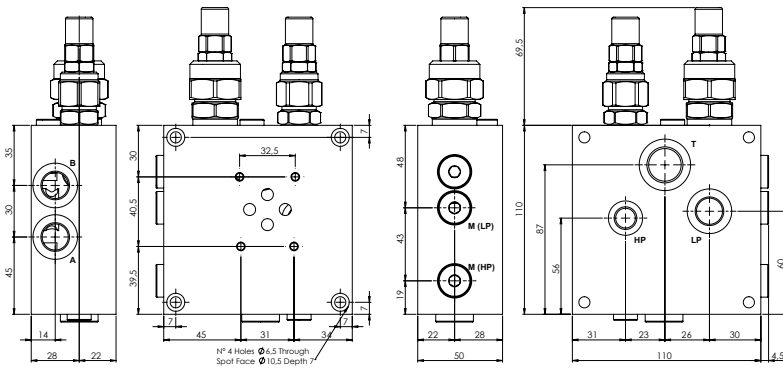

PRESSURE DROP CURVES

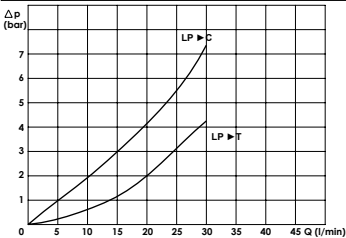

ORDERING CODE:

WEPD

6F

LP - Spring:

- 10 = 5-50
- 20 = 20-260

HP - Spring:

- 20 = 40-210
- 30 = 100-350