

WBS C 60

TECHNICAL DATA

- **Flow:** 60 l/min
- **Max working pressure:** 350 bar
- **Materials:** Cartridge in Steel zinc plated
- **Version:** Poppet Type - Pilot Acting
- **Cavity:** FW7803000
- **Installation torque:** 55-65 Nm
- **Pilot ratio:** 3:1
- **Note:** O-Ring on pilot piston
- **Weight:** 0,100 kg

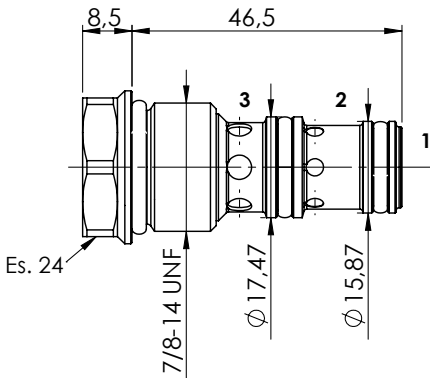
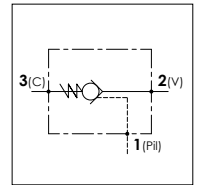

PRESSURE DROP CURVES

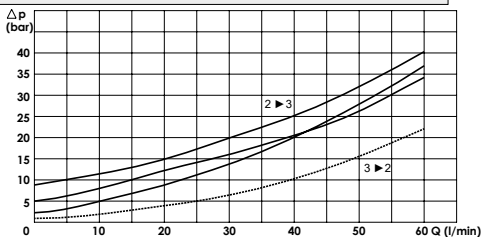

SPRINGS

Code	Cracking pressure bar
1 Standard	2,5
5	5
10	10

ORDERING CODE:

WBS

C

60



G

Opening Pressure:

- Omit if 2,5 bar
- 5 = 5 bar
- 10 = 10 bar