

WTWT S10 02

TECHNICAL DATA

- **Flow:** 20 l/min
- **Max working pressure:** 210 bar
- **Materials:** Cartridge in Steel zinc plated
- **Version:** Spool Type - Direct Acting
- **Cavity:** FW7803000
- **Installation torque:** 40 Nm
- **Weight:** 0,270 kg

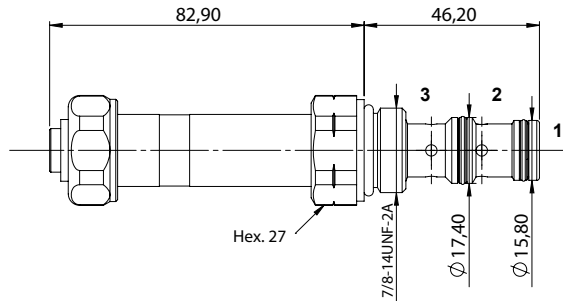
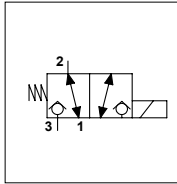

PRESSURE DROP CURVES

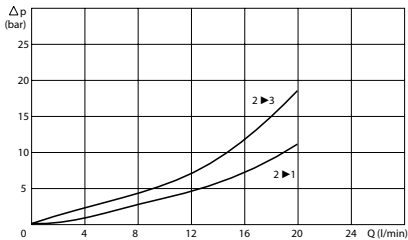

MANUAL OVERRIDE

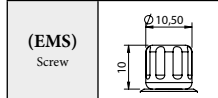

ORDERING CODE

WTWT

S10

02



Manual Override:
- Omit if not required
- EMS = Screw

WTWT S10 02

TECHNICAL DATA

- **Flow:** 20 l/min
- **Max working pressure:** 210 bar (210 bar)
- **Materials:** Aluminium Body (Steel body if required)
- **Version:** Spool Type - Direct Acting
- **Note:** 36W coil on the page 291

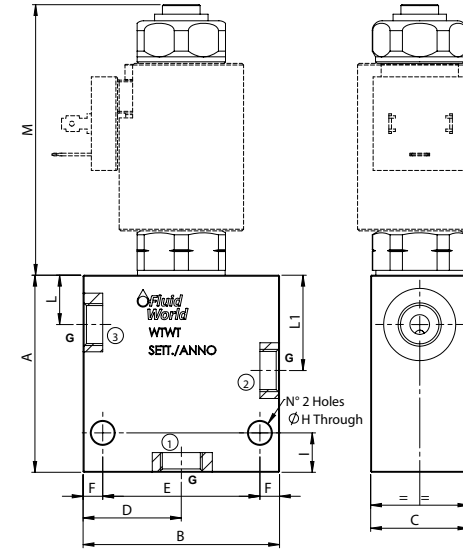
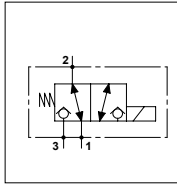

PORTS		
Size	S10	
G	3/8	1/2
DIMENSIONS		
A	60	65
B	60	60
C	30	35
D	30	30
E	46	48
F	7	6
H	7	7
I	12	7
L	15,5	18,5
L1	29,5	34,5
M	82,4	82,4

PRESSURE DROP CURVES

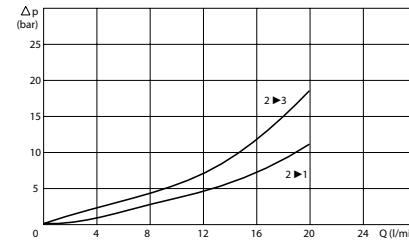

MANUAL OVERRIDE

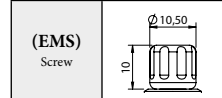

ORDERING CODE

WTWT

S10

02



Manual Override:
- Omit if not required
- EMS = Screw



Ports Size:
- 3/8
- 1/2



Material Body:
- Omit if Aluminium
- S = Steel



Rated Voltage Coil:
- Omit if not required
- 12
- 24